

TO: ALL TRIUMPH DEALERS - WESTERN ZONE

ATTN: SERVICE & PARTS

BULLETIN T-64-1

SUBJECT: SPITFIRE SPEEDOMETER CABLE RUN

DATE: JANUARY 3, 1964

When replacing a broken speedometer cable on the Spitfire model particular care must be taken to eliminate a sharp bend immediately after the gearbox attachment.

The cable run is rather difficult and the following procedure is given as guidance when fitting a new cable.

1. Feed cable through gearbox cover.
2. Fit lower end of cable to gearbox.
3. Fit grommet to cable.
4. Fit cable to instrument
5. Ensure reasonable bends in the upper part of the cable (approx. 13" of cable should be above the cover).
6. Fit grommet to cover.

As the cable tends to be held by the grommet, it is essential that the cable be allowed to take a natural shape before fitting grommet to cover. It should be borne in mind that if an insufficient amount of cable is left above the cover, it will cause an increase in the side loading of the instrument which could cause a seizure.

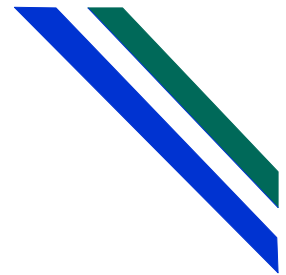

TO: ALL TRIUMPH DEALERS - WESTERN ZONE

ATTN: SERVICE & PARTS

BULLETIN T-64-3

SUBJECT: LAYCOCK OVERDRIVE

DATE: JANUARY 3, 1964

Two basic types of unit known as "A" and "D" are produced. The former is used on cars of two litres (120 Cu. in.) upwards; the "D" type on smaller models.

Both units are pressurized by a plunger type pump, cam operated from the input shaft. Oil is drawn through a filter and delivered to the operating valve. Type "A" incorporates a hydraulic accumulator in the system, type "D" a relief valve. Pressures vary according to the installation but on larger units it is usually 360-520 lb. sq. in. (25.3-36.5 kgs. sq. cm.) and in the smaller about 480 lbs. sq. in. (33.75 kgs. sq. cm.).

Being interconnected, the gearbox and overdrive use a common oil supply, the level of which is indicated by the level plug or dipstick of the gearbox. Although the overdrive unit is filled through the gearbox, separate drain plugs are provided and both must be removed when draining. The overdrive has a gauze filter which should be cleaned whenever the oil is changed. Great care must be taken to avoid entry of dirt whenever any part of the casing is opened.

DIAGNOSIS OF FAULTS

If the overdrive does not operate properly check the oil level in the gearbox! overdrive unit. If low, top up with fresh oil and retest the operation before making a detailed investigation. Before dismantling any part of the overdrive, release all hydraulic pressure from the system by operating the valve setting lever by hand several times. To avoid unnecessary dismantling check for cause in the order listed under the heading below.

(Note: To obtain a hydraulic pressure reading on "D" type, overdrive must be engaged.)

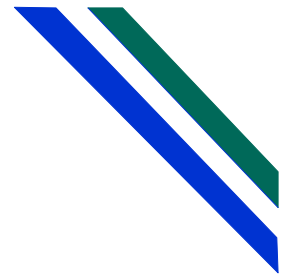

TO: ALL TRIUMPH DEALERS - WESTERN ZONE

ATTN: SERVICE & PARTS

BULLETIN T-64-3

SUBJECT: LAYCOCK OVERDRIVE

DATE: JANUARY 3, 1964

OVERDRIVE DOES NOT ENGAGE

- 1.. Insufficient oil in unit.
2. Solenoid not operating due to fault in electrical system.
3. Solenoid operating lever out of adjustment.
4. Insufficient hydraulic pressure due to pump non-return valve incorrectly seating (probably dirt on seat).
5. Damaged parts within the unit.

OVERDRIVE DOES NOT RELEASE

(Note: Do not attempt to reverse car or damage may be caused within the overdrive.)

1. Fault in electrical control system.
2. Blocked restrictor jet in operating valve.
3. Solenoid operating lever adjustment.
4. Sticking clutch.

CLUTCH SLIP IN OVERDRIVE

As 1, 3 and 4 "Overdrive does not engage."

5. Worn or glazed clutch lining.

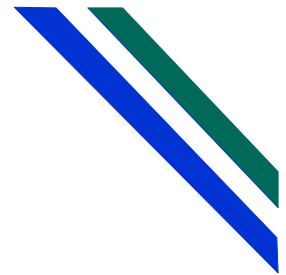

TO: ALL TRIUMPH DEALERS - WESTERN ZONE

ATTN: SERVICE & PARTS

BULLETIN T-64-3

SUBJECT: LAYCOCK OVERDRIVE

DATE: JANUARY 3, 1964

CLUTCH SLIP IN REVERSE AND FREE WHEEL ON OVER-RUN

1. Solenoid operating lever out of adjustment.
2. Partially blocked restrictor jet in operating valve.
3. Worn or glazed clutch lining.

ADJUSTMENT OF SOLENOID OPERATING LEVER

The solenoid operates a lever which is fastened to a shaft carrying the operating cam. In "A" type units, the lever is clamped to the shaft to facilitate adjustment with a setting arm on the opposite side of the unit.

With the solenoid energized the 3/16" (4.5 mm.) hole in the setting arm should align with a similar hole in the casting. The alignment of the holes should be checked by inserting the shank of a 3/16" (4.5 mm.) drill through the hole in the setting arm.

For adjusting the solenoid on "D" type see Service Bulletin 1-63-60. PUMP NON-RETURN VALVE (Figure 1)

In "A" type units access to the valve necessitates removal of the solenoid and solenoid bracket. The bracket is secured by two 5/16" (7.937 mm.) diameter studs and two t/16" (7.937 mm.) diameter bolts, the head of the bolts being painted RED. THE NUTS MUST BE REMOVED FROM THE STUDS BEFORE TOUCHING THE BOLTS. The two bolts should not be slackened off together releasing the compression on the accumulator spring which abuts the solenoid bracket.

After removing the valve plug, spring, plunger and ball, clean the seat and reset the ball by giving it a sharp tap with a suitable hammer and drift.

LEYLAND-TRIUMPH SALES COMPANY, INC.

WESTERN ZONE

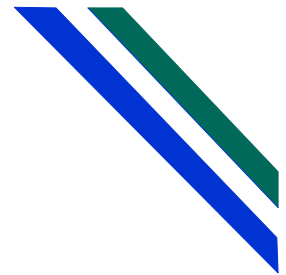

TO: ALL TRIUMPH DEALERS - WESTERN ZONE

ATTN: SERVICE & PARTS

BULLETIN T-64-3

SUBJECT: LAYCOCK OVERDRIVE

DATE: JANUARY 3, 1964

The "D" type has a detachable pump valve accessible from beneath the unit when the center plug is removed. The valve body can then be withdrawn by inserting a piece of stiff wire, bent into a hook, in the hole in the side of the body. After removal of the body, the valve plunger can be pushed out. Inspect the body, plunger, spring and "O" ring for damage. The plunger should be a sliding fit in the body.

OPERATING VALVE

The operating valve plug is located on top of the unit. Release hydraulic pressure, unscrew plug and remove spring, plunger and ball. A small magnet will be found useful for this operation. Remove operating valve by inserting a stiff piece of wire and drawing it up. Near the bottom of the valve will be seen a small hole breaking through the center drilling. Ensure that this is not choked (Figure 2).

If necessary, the ball can be reseated on top of the operating valve by placing the ball on a block of wood and sharply tapping the valve after positioning it on the ball. Clean the valve seat in the casing and if necessary reseat the ball by tapping it gently on its seat with a copper drift. Do not tap the ball too hard or the mouth of the hole will be closed up so that the valve cannot be reassembled.

An Instruction Manual covering the "A" type of unit is available from the Spares Division under publication number 502274. A Manual for the "D" type is in course of preparation.

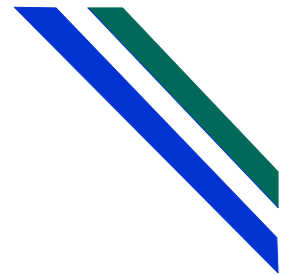

3/63

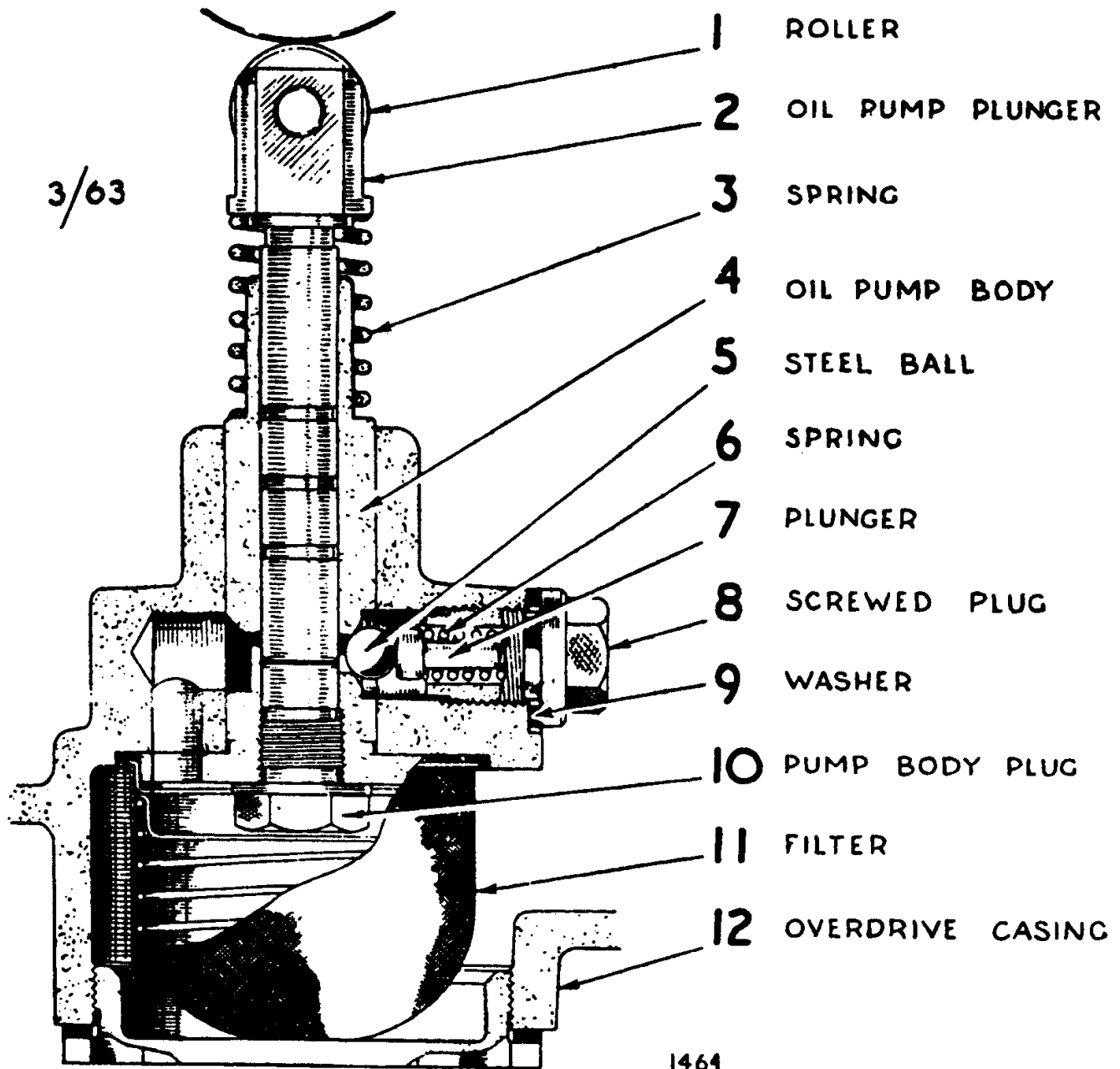

1464

PUMP VALVE
A TYPE ONLY

FIG. 1

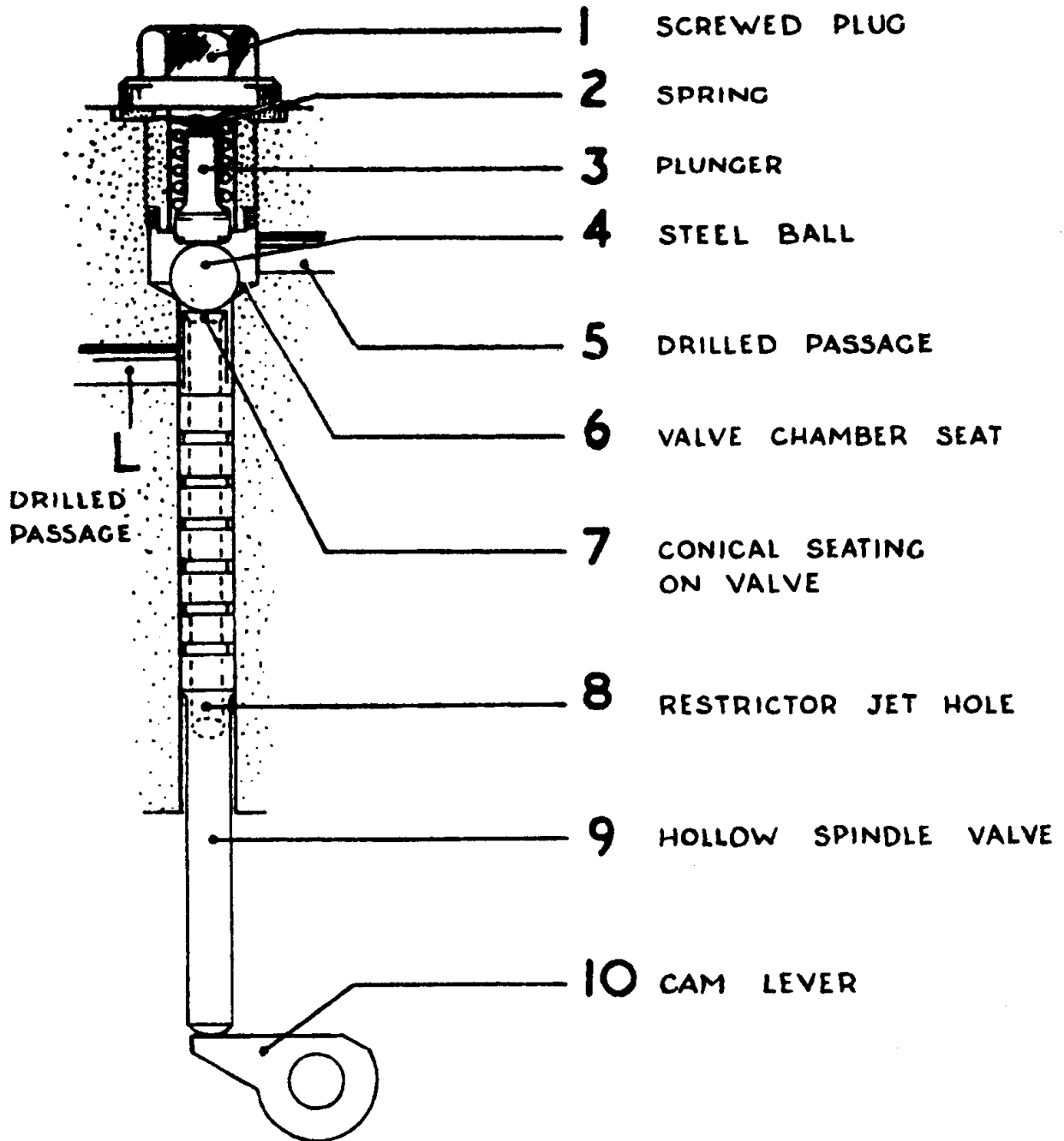
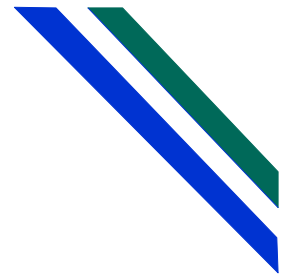

OPERATING VALVE
A AND D TYPE

3/63

FIG. 2

LEYLAND-TRIUMPH SALES COMPANY, INC.

WESTERN ZONE

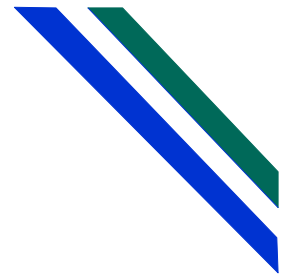

TO: ALL TRIUMPH DEALERS - WESTERN ZONE

ATTN: SERVICE & PARTS

BULLETIN T-64-4

SUBJECT: DISC BRAKE WARRANTY PROCEDURE

DATE: JANUARY 10. 1964

Please advise all concerned to delete disc brake discs. therefore, this part of the item.

of amending vendor item warranty instructions Discs are manufactured by our own company and, assembly should be handled as a normal LTSCI

To avoid the possibility of an abnormal amount of expense that could possibly arise through misinterpretation of these instructions, all discs alleged to be defective must be returned to the Zone or Regional Office for reconditioning and return on an exchange basis.

It must be realized that the friction surfaces of discs will become rusty during storage or even during use of the car where it is parked for any time; therefore, resurfacing of discs for the purpose of removing rust will not be considered as a warranty item and it is for this and other reasons that discs should be returned to the Zone or Regional office for examination and action.

LEYLAND-TRIUMPH SALES COMPANY, INC.

WESTERN ZONE

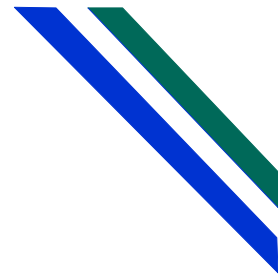

TO: ALL TRIUMPH DEALERS - WESTERN ZONE

ATTN: SERVICE & PARTS

BULLETIN T-64-6

SUBJECT: WARRANTY CLAIMS

DATE: FEBRUARY 7. 1964

It has again become necessary for us to ask your fullest cooperation when filing warranty claims. We refer to the Warranty Filing Instruction Booklet issued November, 1962, which states claims to be accepted must be in our possession with 15 DAYS OF THE DATE OF REPAIR. In possession means that your claims should be filed with the respective zone or regional office, whichever applies to your dealership, within this stated time. To avoid unnecessary delays in the future, please take the following action:

1. Write up the repair order at the time of doing the work and ENTER FULL VEHICLE AND OWNER DETAILS.
2. Submit a copy of the repair order, signed by the OWNER of the vehicle, with the claim form.

It is our wish that you be reimbursed as quickly as possible. Without your cooperation this becomes a difficult task and not only does it cause extra work but very often misunderstanding and this is unnecessary. In the interest of greater quality control, all claims, after processing, are electronically analyzed by type of defect, model, commission number and territory, It is obvious, therefore, that accuracy in description and other details are necessary as the high incident of any one particular complaint in any area will be investigated for a remedy with a minimum of delay.

Please call the above to the attention of all personnel involved with warranty procedure at your dealership and, also, please make sure that they are fully conversant with the Warranty Filing Instruction Booklet issued from this office, dated November, 1962. Should you not have a copy of this available, please let us know and we will send you one by return mail.

LEYLAND-TRIUMPH SALES COMPANY, INC.

WESTERN ZONE

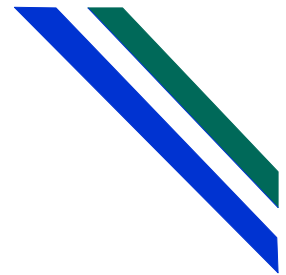

TO: ALL TRIUMPH DEALERS - WESTERN ZONE

ATTN: SERVICE & PARTS

BULLETIN T-64-7

SUBJECT: KNOCK FROM REAR END - 1200 AND SPITFIRE

DATE: FEBRUARY 7, 1964

Isolated cases have been reported of a knock coming from the rear end of the above models when accelerating from stationary and decelerating. It is essential that all nuts and bolts on the driveshaft, universal joints, back plates, radius rods, axle shafts, pinion nuts and vertical links are checked for correct torque. If the knock persists after the above check has been made, the following procedure should be carried out:

The lower pivot bolt on the vertical link should be tightened to torque of 40 to 45 lbs. ft. to take up any slack between the vertical and the nylon bushes. Should the knock still persist at this torque, bolts should be removed and the distance tube pushed out of the nylon and filed down accordingly, replaced and heavy chassis lube applied to of the nylon bush, reassemble and retorque at 40 to 45 lbs. ft. During operation, should the nylon bushes be found to be sloppy fit, this can cause a knock regardless of the correct tightening torque of the pivot bolt; therefore, the bushes should be replaced.

After this operation it is important that the suspension be checked for free movement after the torque has been applied to the lower trunnion pivot bolt.

Please note that a few third members have been changed for this noise but TO NO AVAIL and obviously the claims have been refused. The above information has proved satisfactory, however, in all cases and it is unnecessary to change the third member.

LEYLAND-TRIUMPH SALES COMPANY, INC.

WESTERN ZONE

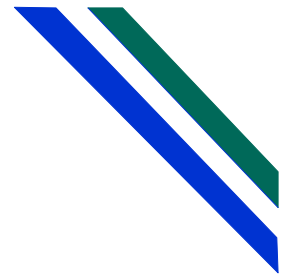

TO: ALL TRIUMPH DEALERS - WESTERN ZONE

ATTN: SERVICE & PARTS

BULLETIN T-64-9

SUBJECT: DECIMAL TIMES ON WARRANTY CLAIMS

DATE: FEBRUARY 14, 1964

To avoid delays in clearing your warranty claims and errors in processing due to misinterpretation of figures, it is essential that all claims containing labor show this in a decimal form rather than minutes or fractions.

The decimal time will be entered in the "Hours" column as a four digit number in the following manner:

A labor time of 8 hours should be shown as 08.00

A labor time of 22 hours should be shown as 22.00

A labor time of 6.3 hours should be shown as 6.30

A labor time of .5 hours should be shown as 00.50

A labor time of .75 hours should be shown as 00.75

LEYLAND-TRIUMPH SALES COMPANY, INC.

WESTERN ZONE

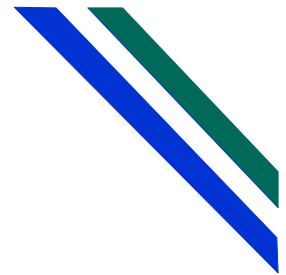

TO: ALL TRIUMPH DEALERS - WESTERN ZONE

ATTN: SERVICE & PARTS

BULLETIN T-64-10

SUBJECT: WARRANTY CLAIMS

DATE: FEBRUARY 21, 1964

To expedite warranty claim procedure, this bulletin is to advise you that on all future warranty claims submitted in regard to vendor items, please make sure that factory numbers are used, not vendor numbers.

This is necessary because our computer is not set to handle any other numbers other than factory numbers.

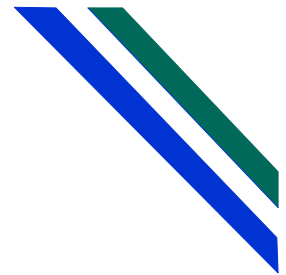

TO: ALL TRIUMPH DEALERS - WESTERN ZONE

ATTN: SERVICE & PARTS

BULLETIN T-64-11

SUBJECT: PAINT COLOR CODING

DATE: MARCH 5, 1964

Paint and trim identification color coding will gradually be introduced on the TR-4, 1200, Spitfire and Sports Six in the near future.

There are nine basic colors which are allocated numbers as follows:

Black	1	Blue	6
Red	2	Purple	7
Brown	3	Gray	8
Yellow	4	White	9
Green	5		

To cover SHADES of these colors, a second figure commencing at one will be used as a prefix and each shade change will be covered by a different prefix number. The current range of colors and shades is as follows:

BASIC COLOR	1st SHADE	2nd SHADE	3rd SHADE	4th SHADE
Black	11			
Red	12-Matador	22-Cherry	32-Signal	
Brown	13			
Yellow	<u>14-Jonquil</u>			
Green	15-Cactus	<u>*25 Conifer</u>	35-Olive	
Blue	16-Midnight	<u>26-Wedgewood</u>	36-Dark Blue	
Purple	17			
Gray	18-Gunmetal	28-Dark Gray		
White	<u>19</u>			

*Known in the U.S.A. as Triumph Racing Green.

Dual paint colors will be shown as two codes divided by a stroke.

LEYLAND-TRIUMPH SALES COMPANY, INC.

WESTERN ZONE

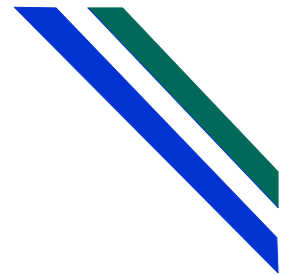

TO: ALL TRIUMPH DEALERS - WESTERN ZONE

ATTN: SERVICE & PARTS

BULLETIN T-64-11

SUBJECT: PAINT COLOR CODING

DATE: MARCH 5, 1964

Example: 35/15 Olive Green and Cactus Green, with Olive Green as the predominating color.

For clarity of example, a selection of colors used on other models not imported in the U.S.A. are shown. This does not mean that there will be an extension of the current color selection. Colors current in the U.S.A. have been underlined for ease of recognition.

The commission number plate will have two additional spaces, the first space being used to denote the exterior paint code and the second space to denote the trim code.

Typical examples are:

Commission number GA47876-L
Paint 19/11 - Trim 12

Denotes dual tone white/black with matador red trim with white the predominant color.

Commission number CT-64697-L
Paint 26 - Trim 16

Denotes monotone Wedgewood blue with midnight blue trim.

The use of the code will enable the correct shade of paint or trim to be ordered from the Parts Division when the occasion arises.

LEYLAND-TRIUMPH SALES COMPANY, INC.

WESTERN ZONE

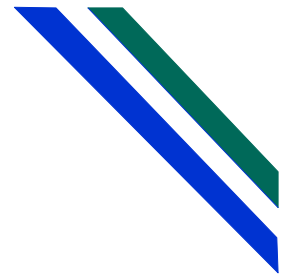

TO: ALL TRIUMPH DEALERS - WESTERN ZONE

ATTN: SERVICE & PARTS

BULLETIN T-64-12

SUBJECT: INCREASED ALLOWANCES AND
WARRANTY CLAIMS SWAP-OUT SETS

DATE: MARCH 20, 1964

Commencing with warranty labor performed on and after March 20, 1964, labor reimbursement will be adjusted to a warranty hourly labor rate based on official statistical information and area surveys. No other changes will be made to the warranty terms or periods but dealers' own individual recommendations for policy adjustments will always be considered.

Dealers will be advised by individual letters of the new rates that will be applicable. It is hoped that this adjustment will facilitate the handling of warranty rectifications whether regular or transient on the same basis as regular shop work.

As a further aid in the preparation of warranty claims, we are pleased to announce the introduction of a pre-carbon claim formset. Six copies of this are enclosed with this bulletin and further supplies can be obtained from the Zone or Regional Offices, whichever applies to your dealership.

With a view to economy, we would like to suggest the old type of form be used as a rough work sheet, so that any errors will not result in wastage of complete sets of the new form.

It will be noted that the form itself has not been changed insofar as layout is concerned except to provide a little more space for "nature of defect."

To insure fast warranty expenditure return, please avoid errors. As you will note, the new forms are for use by automatic computers.

Please make sure that the new labor rate sent to you is inserted on all future claims after March 20, 1964.

LEYLAND-TRIUMPH SALES COMPANY, INC.

WESTERN ZONE

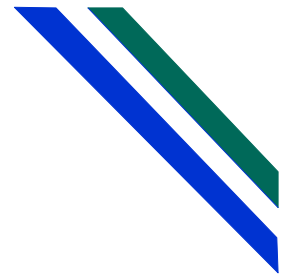

TO: ALL TRIUMPH DEALERS - WESTERN ZONE

ATTN: SERVICE & PARTS

BULLETIN T-64-13

SUBJECT: BENDIX PUSH-BUTTON RADIO

DATE: MARCH 6, 1964

Your attention is called to the fitting of the current Bendix Push-Button Radio. A number of these have been returned for faulty operation and have been turned down by the Bendix Corp. for the following reasons:

It has been noted the adaptor plate the securing nuts failure of the unit.

that the chrome bezel has been fitted on the wrong side of when fitting the radio into Triumph models; therefore, when are tightened distortion takes place in the radio set causing

Please make sure that when fitting Bendix radios in the future that the instructions inside each kit are thoroughly followed as it clearly shows the correct method of fitting the bezel in position which, of course, is directly on to the radio receiver and then the radio and bezel inserted into the adaptor plate from the rear, then the securing nuts tightened accordingly. When the completed installation is securely in position only a small portion of the chrome bezel can be seen when sitting in the driver's seat.

This is the correct installation and no problem should then be experienced with the radio set. However, we must emphasize that the instructions issued with each set should be thoroughly read and understood on each model as there is a slight variation to fitting.

LEYLAND-TRIUMPH SALES COMPANY, INC.

WESTERN ZONE

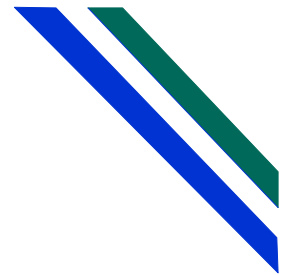

TO: ALL TRIUMPH DEALERS - WESTERN ZONE

ATTN: SERVICE & PARTS

BULLETIN T-64-15

SUBJECT: CENTER VALVE MASTER CYLINDER
SEALS - SMALL CAR RANGE

DATE: MAY 8. 1964

With the introduction of "single seal plungers" by Messrs. Girling, Ltd., some months ago, the following changes were made:

1. The groove for the end seal was deleted on the new plunger.
2. The taper end seal was deleted.

All service kits, 505100, include the new seal but the taper end seal has been omitted. When servicing earlier master cylinders with the kit, the end seal groove of the piston (nearest the push-rod) is left vacant and filled with red rubber grease. This kit can be used for either plunger condition.

Stocks of kit number 503492 are still being issued from the parts department which contain both seals and these must only be used for servicing the earlier type of plunger with two grooves.

All dealers have been issued with an illustrated Lucas/.Girling bulletin on this subject by Lucas, New York. Please advise if you have not received copies from Lucas, so that they may be supplied. The Lucas bulletin should be filed with this bulletin.

LEYLAND-TRIUMPH SALES COMPANY, INC.

WESTERN ZONE

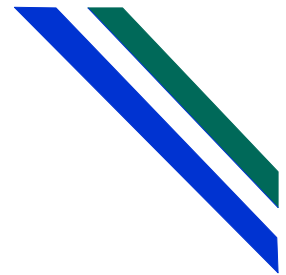

TO: ALL TRIUMPH DEALERS - WESTERN ZONE

ATTN: SERVICE & PARTS

BULLETIN T-64-16

SUBJECT: TRIUMPH 1200, SPITFIRE AND
SPORTS SIX VALVE SPRINGS

DATE: MAY 29.1964

With the introduction of the single heavier valve springs in place of the double springs, it is essential that correct replacements are fitted when necessary.

The outer spring, 121251, must not be used as a single spring to replace 136487 and conversely 136487 must not be used in place of 121251 with inner spring 102564.

Both items should be segregated under the respective part numbers in your Parts Department.

PLEASE ENSURE THAT ALL PARTS DEPARTMENTS ARE ALERTED TO THIS IMPORTANT INFORMATION.

LEYLAND-TRIUMPH SALES COMPANY, INC.

WESTERN ZONE

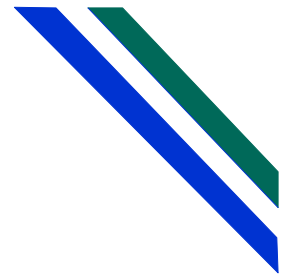

TO: ALL TRIUMPH DEALERS - WESTERN ZONE

ATTN: SERVICE & PARTS

BULLETIN T-64-17

SUBJECT: SPITFIRE EXHAUST SYSTEM

DATE: JUNE 26, 1964

A modification to the exhaust mountings was incorporated at commission number FC-28017. Details of affected clips and brackets are given in the Spitfire Spare Parts Catalog, Amendment No. 4, July, 1963.

Retrospective action is not called for but note should be taken that the revised mountings necessitate the drilling of a $21/64$ " (.328") hole in the rear axle mounting plate to accommodate an additional bracket. (New part number 211544 in place of 209333.)

The revised mounting plate and axle unit is identical in every other respect and can be used on cars prior to this introduction, although the hole will be surplus. The earlier type axle and mounting plate can also be used for exchange purposes on cars after FC-28017 provided that the plate is drilled.

The position for drilling can be obtained from the axle being replaced.

The mounting plate is common to the 1200, Sports Six and Spitfire and will be drilled on all these models in future, although no exhaust modification is anticipated.

LEYLAND-TRIUMPH SALES COMPANY, INC.

WESTERN ZONE

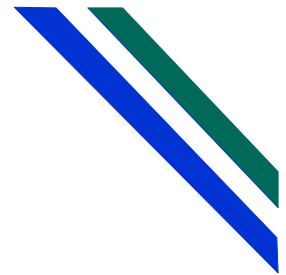

TO: ALL TRIUMPH DEALERS - WESTERN ZONE

ATTN: SERVICE & PARTS

BULLETIN T-64-18

SUBJECT: TR-4 TIRE EQUIPMENT

DATE: JUNE 26, 1964

The specification of the TR-4 now includes Goodyear "Grand Prix" tires to the exclusion of Rayon, Nylon and Motorway tires. In the U.S.A. only, the same tire will be marketed under the name "Power Cushion."

These tires are capable of coping with maximum speeds without alteration to the tire pressures which are front 20 p.s.i., rear 24 p.s.i., for all driving conditions. The same pressures apply to cars having the earlier or later type of rear suspension.

Tubeless "Grand Prix" whitewall tires were introduced at CT-31667 and tubeless "Grand Prix" black tires at CT-32153.

The "Power Cushion" tire made in the U.S.A. is the equivalent but does not match the "Grand Prix" tire. Goodyear hold stocks of the British made "Grand Prix" tire to handle incidental replacements but replacement of complete sets of tires should be with the "Power Cushion" type.

LEYLAND-TRIUMPH SALES COMPANY, INC.

WESTERN ZONE

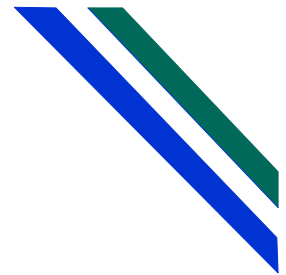

TO: ALL TRIUMPH DEALERS - WESTERN ZONE

ATTN: SERVICE & PARTS

SUBJECT: SPITFIRE HARDTOP SEALING

BULLETIN T-64-19

DATE: JUNE 26, 1964

When fitting a hardtop to the Spitfire it is essential that an enlarged sealing rubber, part numbers 616428 and 616429, is fitted in the cant rail to ensure adequate sealing between drop glass and hardtop.

To permit a common condition to suit either hard or soft top, the height of the droplight must be adjusted to 12 3/4" from the top edge of the door frame.

To position the glass to the above dimension, a special large glass stop nut 1/4" UNF x 3/8" AF x 1/2' thick, part number 616506, may be used on the regulator in place of the 1/4" UNF jam nut.

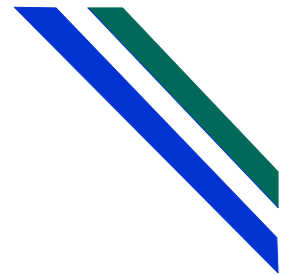

TO: ALL TRIUMPH DEALERS - WESTERN ZONE

ATTN: SERVICE & PARTS

BULLETIN T-64-20

SUBJECT: TRIUMPH SPITFIRE BODY WATER LEAKS

DATE: JULY 2, 1964

The Workshop Manual, part No. 511243, describes the dust and water sealing procedure in Group 5, Section 3, Page 5.309. This bulletin deals with possible points of water entry additional to those outlined in the Manual and enlarges on some of those already detailed. Reference should, therefore, be made to the Workshop Manual when undertaking dust and water sealing rectification.

Small changes in body design have been introduced since first production and the items detailed below may not necessarily apply to all Spitfires.

1. Check for gaps at the top lap joint beneath the chrome finisher at the top of the "B" post. Brush in any gaps with sealer.
2. Check for gaps between the inner and outer wheel arch panels and beneath the rear wing chrome finisher strips along the top of the rear wing paying particular attention to the extreme ends of the seams. See illustration C.512/14 on Page 5.312 of the Manual. Brush in any gaps with sealer.
3. Check for gaps at rear/tail lamp body securing screw and gasket. See Illustration C.512/18 on Page 5.313 of the Manual. Use Seelastik to fill any gaps.
4. Check for gaps at the inner sill panel to "B" post base closing plate joint. This joint runs vertically through an elongated hole in the rear of the inner body sill panel, just forward of the rear suspension radius rod attachment bolts. The elongated hole is shown in illustration C.512/12 on Page 5.312 of the Manual. Brush in sealer to fill any gaps.

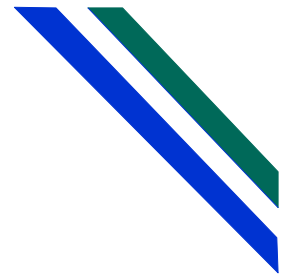

TO: ALL TRIUMPH DEALERS - WESTERN ZONE

ATTN: SERVICE & PARTS

BULLETIN T-64-20

SUBJECT: TRIUMPH SPITFIRE BODY WATER LEAKS

DATE: JULY 2, 1964

5. Check for any gaps between the rear bumper mounting bracket grommets and the mounting bracket on the body. Fill in any gaps with Seelastik.

6. Remove door internal handles and trim casing and seal all holes in the internal door panels with waterproof tape, including door lock across holes.

7. Seal heater unit at mounting gasket and heater pipe grommets at bulkhead with Seelastik. See Illustration C.512/4 on Page 5/310 of the Manual.

8. To prevent a build up of water at the base of the door, early cars were fitted with a separate door rubber seal inserted in a channel pop-riveted to the door aperture. "A" Fig. 1. Assist the drainage by drilling three equidistant 3/16" die. holes in the top of the body sill panel in-board of the riveted channel at the bottom of the door aperture. "B" Fig. 1. To allow drainage from the body sill, a drain hole 1/4" dia. should be drilled at the rear wheel arch end of the outer sill panel at its lowest point. "C" Fig. 1

The later type of door aperture sealing rubber, part No. 707931, which combines the aperture sealing rubber and aperture flange finisher may be fitted. "D" Fig. 1. The original channel for the older type rubber should be retained as the new rubber fitted to the aperture flange will almost conceal it.

9. The door check strap sealing rubber was originally attached to the door. On these cars the check strap should be disconnected, the rubber removed from the door and reattached to the "A" post with a suitable adhesive. Reconnect the check strap.

LEYLAND-TRIUMPH SALES COMPANY, INC.

WESTERN ZONE

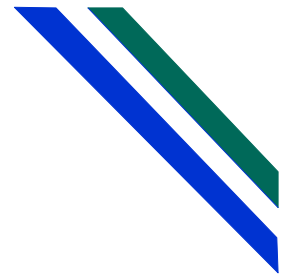

TO: ALL TRIUMPH DEALERS - WESTERN ZONE

ATTN: SERVICE & PARTS

BULLETIN T-64-20

SUBJECT: TRIUMPH SPITFIRE BODY WATER LEAKS

DATE: JULY 2, 1964

10. A "P" section rubber, part number 651842, as now fitted to the "A" post and screen pillar, allowing each coat to dry before applying a further coat. Brush sealer be fitted to any car not so equipped by attaching with a suitable adhesive. See Fig. 2 "E" for correct positioning of rubber to screen pillar and "A" post.

11. All stitched hood seams should be sealed with three of four coats of "Brush stitch sealer" allowing each coat to dry before applying a further coat. Brush Sealer may be obtained under part numbers Clear 552895 for use on white hoods and Black 5~A616 for use on black hoods.

12. Hard top aperture sealing rubbers. Instructions and method of adjusting drop light glass to achieve a correct seal between rubber and drop light glass are detailed in Bulletin 1-64-19.

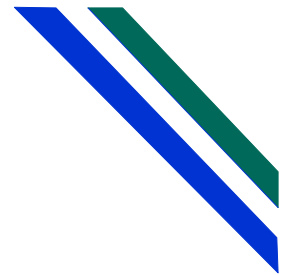

FIG. 1.

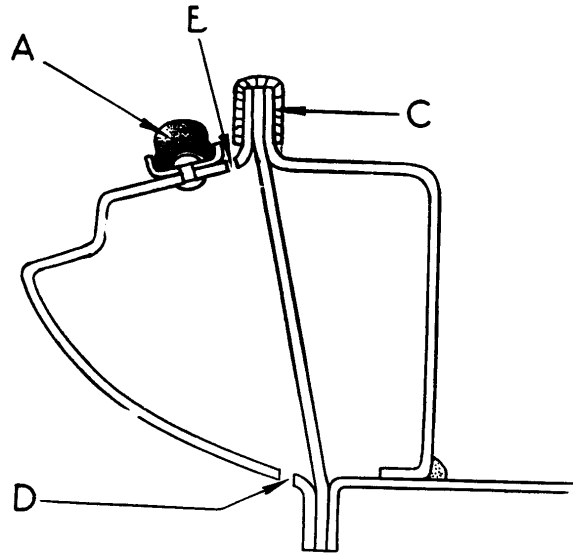
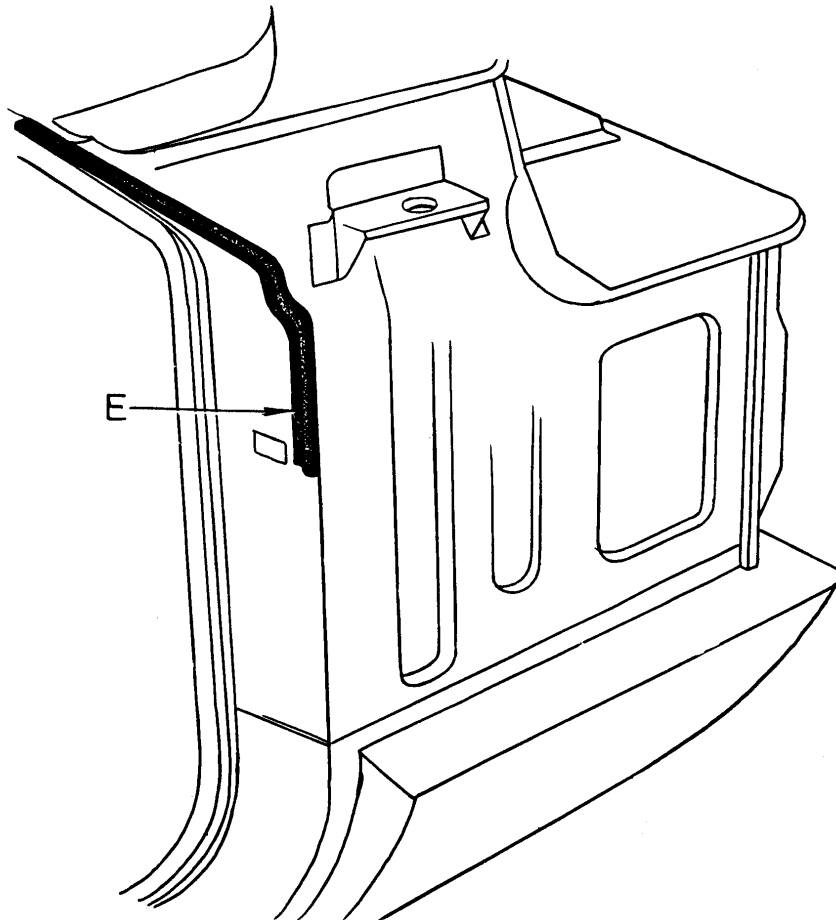
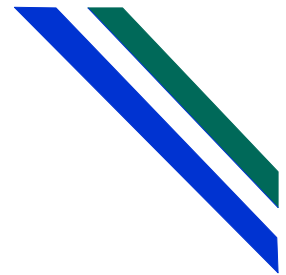

FIG. 2.



LEYLAND-TRIUMPH SALES COMPANY, INC.

WESTERN ZONE



TO: ALL TRIUMPH DEALERS - WESTERN ZONE

ATTN: SERVICE & PARTS

BULLETIN T-64-21

SUBJECT: MAINTENANCE PERIODS

DATE: JULY 10, 1964

With the introduction of extended servicing periods, you are reminded that these require realistic interpretation according to the conditions under which the vehicles are operated.

The attention of all concerned, therefore, should particularly be drawn to the special amendments set out on Page 8 in the new Voucher Books.

The instructions concerning air cleaner maintenance contained in the Owner's Handbook for both the TR-4 and Spitfire should be carefully observed in relation to both the frequency of servicing and the method of servicing. It is insufficient to apply a few drops of oil to the gauze of the air cleaner, these must be soaked in engine oil after cleaning in accordance with the instructions.

LEYLAND-TRIUMPH SALES COMPANY, INC.

WESTERN ZONE

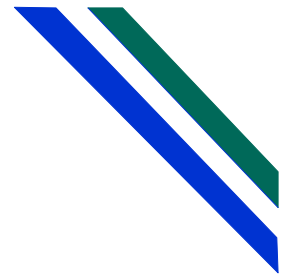

TO: ALL TRIUMPH DEALERS - WESTERN ZONE

ATTN: SERVICE & PARTS

BULLETIN T-64-23

SUBJECT: TRIUMPH TR-4 WIRE WHEEL CONVERSION

DATE: JULY 17. 1964

When converting from disc wheels to wire wheels on TR4 models in service, it is essential that the original wheel studs are shortened by approximately 5/16" when installing the hub extensions.

Failure to do so will result in the studs fouling the inside of the wire wheels, preventing adequate tightening by the center wheel nuts.

If reversing the process, the short studs used for the extensions will be inadequate for securing disc wheels and longer studs, part number 114282 front, 103869 rear, must be fitted.

it is most important that the attachment nuts are initially tightened to a torque of 65 lbs. ft. after which the vehicle should be run approximately 10 miles and the torque tightness rechecked. This should normally allow any settlement between the surfaces of the hubs and adaptors to be accommodated and prevent subsequent loosening of nuts after further running but additional checks should be carried out as detailed below.

Although the tightness of attachment nuts are double checked in production on cars when fitting these adaptors, it is nonetheless important that this attention should be still given, as specified, during the pre-delivery check and first service. Equivalent checks should also be carried out with cars converted to accommodate wire wheels after dispatch from the factory.

This information was originally given in bulletin T-63-51 and the Triumph TR-3 Workshop manual but it is felt desirable to circulate it in reference to current models.

LEYLAND-TRIUMPH SALES COMPANY, INC.

WESTERN ZONE

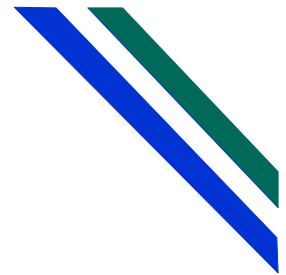

TO: ALL TRIUMPH DEALERS - WESTERN ZONE

ATTN: SERVICE & PARTS

BULLETIN T-64-24

SUBJECT: SPITFIRE REAR ROAD SPRINGS

DATE: JULY 17. 1964

This information is to supplement that already given cover a number of recent inquiries.

The specified rear wheel camber for Spitfire models in the static condition in Bulletin 1-63-50 is unchanged but an additional check may be carried out with the car in a static laden condition in which the rear wheel camber should be 3° negative. Static laden condition in this case means with a full complement of fuel, oil and water plus 120 lbs. weight on each front seat.

If the car is loaded beyond the static laden condition, as often is the case during vacation periods, the negative camber may be expected to exceed the above reading but this does not indicate any weakness in the rear spring nor will it result in any damage if kept to within a reasonable condition of load.

LEYLAND-TRIUMPH SALES COMPANY, INC.

WESTERN ZONE

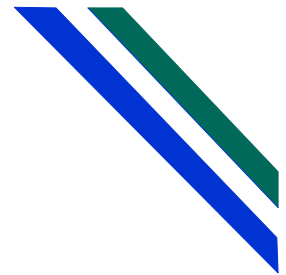

TO: ALL TRIUMPH DEALERS - WESTERN ZONE

ATTN: SERVICE & PARTS

SUBJECT: SPITFIRE & 1200 PROPELLER SHAFTS

BULLETIN T-64-25

DATE: JULY 17. 1964

Bulletin T-63-57 gave information concerning servicing of frictionless propeller shafts.

Please note that the frictionless type of propeller shaft has now been deleted for the regular type from the following serial numbers:

Spitfire - FC-1876
1200 - GD-15853

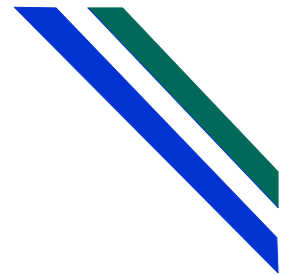

TO: ALL TRIUMPH DEALERS - WESTERN ZONE

ATTN: SERVICE DEPARTMENT

BULLETIN T-64-26

SUBJECT: 1200 HERALD CLUTCH SLIP

DATE: JULY 24, 1964

Since the introduction of the additional return spring to overcome the effect of pedal riding at GA-117717 some pedals may have been released with an incorrectly positioned spring retaining bracket, part number 136466.

This results in binding of the spring between the pedal and bracket which prevents full return of the clutch pedal on release.

When any complaint of clutch slip is dealt with, the condition of the pedal should be checked.

To determine if a pedal is faulty, disconnect the master cylinder push rod from the pedal.

If, when the clevis pin is removed, the push rod continues to spring back past the line of engagement with the clevis pin and pedal, the pedal must be changed for a new one, part No. R.H.S. 137820 and L.H.S. 137746.

To ensure full engagement of the clutch and recuperation of the master cylinder, a small amount of backlash must be evident between the push rod and master cylinder piston when the clevis pin is reinserted.

The following list of driven plates refers to the model for which they are specified.

Part Numbers and Models

Driven Plate	210910	TR-10, Herald 948 c.c. & Herald 1200
Driven plate	210562	Spitfire only

LEYLAND-TRIUMPH SALES COMPANY, INC.

WESTERN ZONE

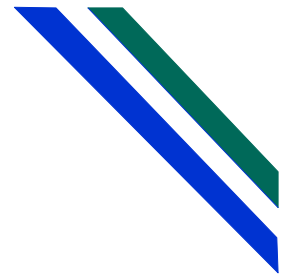

TO: ALL TRIUMPH DEALERS - WESTERN ZONE

ATTN: SERVICE DEPARTMENT

BULLETIN T-64-27

SUBJECT: CORRECTION & ADDITION TO
FLAT RATE TIME SCHEDULE

DATE: AUGUST 14, 1964

Please advise your personnel who use the Flat Rate Manuals to make the following correction and addition:

CORRECTION

<u>OPERATION NO.</u>	<u>DESCRIPTION</u>	<u>MODEL</u>	<u>HOURS</u>
6-126B	Remove & Replace Starter Motor	1200	00.50

ADDITION

6-143C	Replace loom	Spitfire	06.40
--------	--------------	----------	-------

At the same time we would like to remind you of a previous addition, reference Bulletin T-64-22.

S.T.	Replace heater core unit and/or fan	TR-4 Spitfire	02.00 02.75
------	--	------------------	----------------

LEYLAND-TRIUMPH SALES COMPANY, INC.

WESTERN ZONE

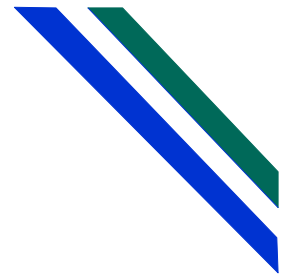

TO: ALL TRIUMPH DEALERS - WESTERN ZONE

ATTN: SERVICE AND PARTS DEPARTMENT

SUBJECT: OIL IN SPEEDOMETERS

BULLETIN T-64-28

DATE: SEPTEMBER 4, 1964

This bulletin is to remind you of the procedure when a speedometer becomes contaminated with oil through failure of an oil seal in the speedometer drive allowing the oil to be pumped up the cables into the speedometer head.

The speedometer should be removed from the vehicle, labeled and returned for exchange. The inner cable should be removed, surplus oil cleaned off and reassembled. The oil seal, part number 60247 for the TR-4 and part number 108757 for the 1200, Spitfire and Sports Six, should be changed in all cases. A warranty claim will be accepted in the normal way for the labor on the above operation and the instruments exchanged in the normal vendor manner. Under no circumstances will instruments be accepted for warranty exchange if they have been tampered with.

THE ABOVE PROCEDURE MUST BE ADHERED TO, OTHERWISE A WARRANTY CLAIM CANNOT BE ACCEPTED FOR A SPEEDOMETER FAILURE UNDER THIS CATEGORY AND THE MATTER WILL NOT BE OPEN FOR FURTHER DISCUSSION OR CONSIDERATION.

LEYLAND-TRIUMPH SALES COMPANY, INC.

WESTERN ZONE

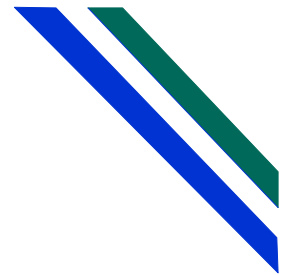

TO: ALL TRIUMPH DEALERS - WESTERN ZONE

ATTN: SERVICE AND PARTS DEPARTMENT

SUBJECT: TR-4 FRONT SUSPENSION

BULLETIN T-64-29

DATE: SEPTEMBER 4, 1964

Effective from commission number CT-29985 the two packing pieces, part number 107682 and two rubber washers, part number 100751 and two front springs, part number 201898, have been deleted.

The new specification calls for two front springs, part number 210903.

The new springs do not require the packing pieces and are interchangeable with the existing condition. They should be serviced in pairs preferably but under certain circumstances one side may be changed without ill effect.

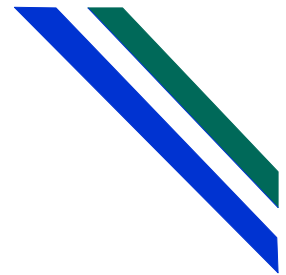

TO: ALL TRIUMPH DEALERS - WESTERN ZONE

ATTN: SERVICE AND PARTS DEPARTMENT

BULLETIN T-64-30

SUBJECT: SPITFIRE DISTRIBUTOR TIMING

DATE: SEPTEMBER 18, 1964

This bulletin is issued as a reminder when tuning the Spitfire engine fitted with the Delco Remy distributor. The point gap setting is .015" in conjunction with the static ignition timing of 13° BTDC.

The Delco Remy distributor manual advance adjustment is one click represents 1° crankshaft rotation.

SPITFIRE TUNING DATA

The following details apply to the Delco Remy distributor fitted to the Triumph Spitfire:

Spark Plug Gap (In.)	0.025"
Breaker Point Cap (In.)	0.015"
Dwell Angle	38°
Begin Centrifugal Advance Test (Deg. @ Crankshaft RPM)	0° - 1.5° 1000 R.P.M.
Max. Centrifugal advance (Deg. @ Crankshaft RPM)	13° Max. @ 5000 R.P.M.
Begin Vacuum Advance Test (In. of Mercury)	2 - 4 ins. HG
Max. Vacuum Advance (Deg. @ In. Mercury)	9° - 11° @ 10 ins. HG

LEYLAND-TRIUMPH SALES COMPANY, INC.

WESTERN ZONE

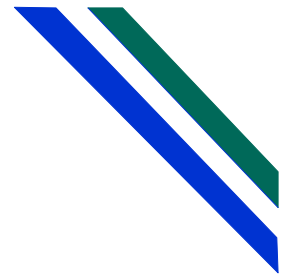

TO: ALL TRIUMPH DEALERS - WESTERN ZONE

ATTN: SERVICE DEPARTMENT

BULLETIN T-64-31

SUBJECT: BRAKE WARRANTY

DATE: SEPTEMBER 25, 1964

Further to Bulletin T-63-62, this is to remind all concerned that any friction components of a braking system such as brake pads and brake linings are not usually covered by manufacturer's or vendor's warranty. The reason for this is that friction components are generally subjected to many different conditions which can affect their life and serviceability.

Brake linings from the small car range of models have occasionally been submitted for warranty consideration due to the fact that they have deteriorated, turned a green color and have commenced to flake. Examination of brake linings in this condition by our own laboratory has definitely established that this condition is typical of and has undoubtedly been brought about by running the car with the brake applied while the linings are in a damp condition.

Brake linings in this condition also have a very characteristic musty odor and the foregoing description and notes are given to assist all concerned to make an immediate decision on receiving inquiries for brake lining replacement.

LEYLAND-TRIUMPH SALES COMPANY, INC.

WESTERN ZONE

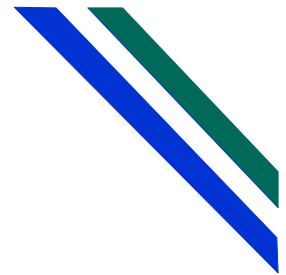

TO: ALL TRIUMPH DEALERS - WESTERN ZONE

ATTN: SERVICE

BULLETIN T-64-32

SUBJECT: TR-4 SOLENOIDS

DATE: SEPTEMBER 25, 1964

In the event of replacement of TR-4 starter solenoids becoming necessary due to damage from carburetor gasoline seepage, it should be relocated approximately 4" further over to the right on the firewall to avoid recurrence.

The solenoid is currently attached to the firewall by bolts and captive nuts. After removing the solenoid, replace the bolts in the holes that are left vacant and attach the solenoid in the new position using metal thread attachment screws or bolts if preferred.

The existing wiring is long enough to accommodate fitting the solenoid in the new position and inasmuch as the additional time involved for relocating the solenoid is fractional, the labor time entailed is approximately the same as the straight out replacement in its present position.

LEYLAND-TRIUMPH SALES COMPANY, INC.

WESTERN ZONE

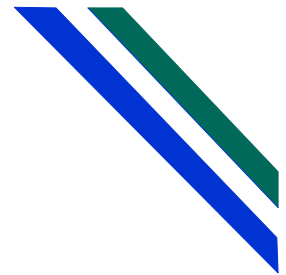

TO: ALL TRIUMPH DEALERS - WESTERN ZONE

ATTN: SERVICE DEPT.

BULLETIN T-64-33

SUBJECT: GOODYEAR GRAND PRIX TIRES

DATE: SEPTEMBER 25, 1964

The Goodyear Tire Corporation advise that they now hold a limited stock of Grand Prix Tires at their New Brunswick, New Jersey, warehouse to cover any replacements that may be required for making good marine damage or warranty replacement in individual cases.

In the event of any dealer or owner requiring matching tires as described in Bulletin T-64-16, they should apply through the nearest Goodyear outlet and if any doubt refer that source to this information.

LEYLAND-TRIUMPH SALES COMPANY, INC.

WESTERN ZONE

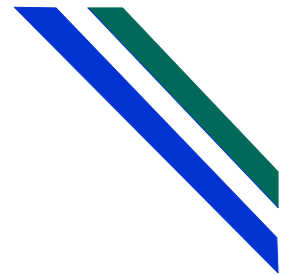

TO: ALL TRIUMPH DEALERS - WESTERN ZONE

ATTN: SERVICE DEPARTMENT

SUBJECT: TIME SCHEDULE AMENDMENT

BULLETIN T-64-34

DATE: OCTOBER 23, 1964

Operation Number 6-126B

Please amend the current Flat Rate Time Schedule for the above operation to one hour for all models.

This should be shown on a claim as 0100.

LEYLAND-TRIUMPH SALES COMPANY, INC.

WESTERN ZONE

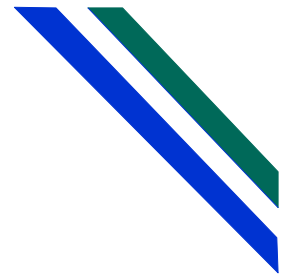

TO: ALL TRIUMPH DEALERS - WESTERN ZONE

ATTN: SERVICE DEPARTMENT

BULLETIN T-64-35

SUBJECT: TRIUMPH-AIRE WARRANTY

DATE: OCTOBER 20. 1964

Please note the warranty on air condition units should be handled entirely as a vendor item inasmuch as defective units or parts are to be obtained on an exchange basis from the Vornado dealers. Labor for removal and installation may be processed on a normal LTSC1 claim through the zone.

The other alternative to this procedure is where the repair is handled in its entirety by the Vornado dealer; in each case he will process his own claims directly with the vendor and nothing further involves the Triumph dealer.

Packed in each V360 Air Conditioning Kit is a warranty registration card, a list of Vornado dealers and warranty filing instructions.

LEYLAND-TRIUMPH SALES COMPANY, INC.

WESTERN ZONE

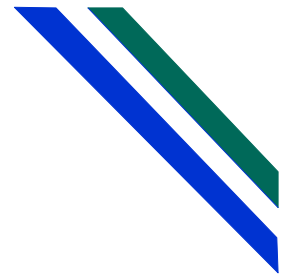

TO: ALL TRIUMPH DEALERS - WESTERN ZONE

ATTN: SERVICE DEPARTMENT

SUBJECT: LUCAS SEALED BEAM UNITS

BULLETIN T-64-36

DATE: OCTOBER 23, 1964

We will gradually be phasing into new cars equipped in England with the Lucas 7" diameter sealed beam.

This is to confirm that the lens will be marked "Lucas Sealed Beam 2" and on the back of the reflector are the markings "BSB6012 12V 50/44 L.H.D."

it is also confirmed that these sealed beam units are approved in all states and the ETL Certificate Number is 386432 dated February 28, 1963, and the California Approval is Number 8234 dated June 21, 1963.

LEYLAND-TRIUMPH SALES COMPANY, INC.

WESTERN ZONE

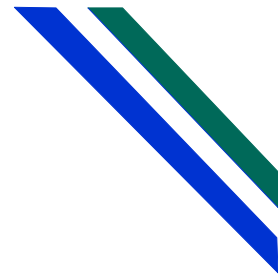

TO: ALL TRIUMPH DEALERS - WESTERN ZONE

ATTN: SERVICE DEPARTMENT

BULLETIN T-64-37

SUBJECT: LEAKING HEATER RADIATOR CORES

DATE: DECEMBER 3, 1964

This bulletin is to advise you that all future repairs found necessary on heaters, inside the warranty period, due to a leaking radiator core, our policy is to exchange radiator for radiator the same as any other vendor item; therefore, we will not accept any outside repair invoices after receipt of this bulletin.

The radiator cores are now stocked in our parts department under the following part numbers:

SHF 7925/01	Spitfire
SHF 7930	TR-4
SHF 7552	Triumph 1200 and Sports 6

To enable our stocks to be maintained correctly it is essential that you return the old heater core to the parts department from which you purchased the replacement radiator core, labeled in the correct manner with all pertinent information.

Warranty claim forms will be accepted in the normal way for R & R radiator core. The time allowed for this operation is as follows:

TR-4	02.00
Triumph 1200	01.00
Spitfire	02.75

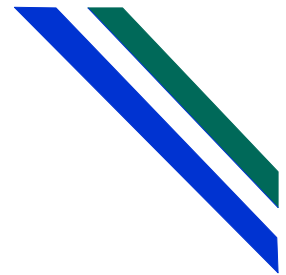

TO: ALL TRIUMPH DEALERS - WESTERN ZONE

ATTN: SERVICE DEPARTMENT

BULLETIN T-64-38

SUBJECT: TRIUMPH SPITFIRE TEMPERATURE
GAUGE TRANSMITTER

DATE: NOVEMBER 25, 1964

For complaints of low or nil temperature reading on the Triumph Spitfire, the transmitter should immediately be suspected, as faults in manufacture have been found.

Each transmitter is date coded in addition to the Smiths part number and codes 5/4, 6/4 and 7/4 (May, June and July 1964) are particularly suspect. Date codes before and after should be satisfactory.

There is also the possibility that another range of transmitter may have been fitted in error, which will also result in a false instrument reading.

In addition to part numbers, identification of the correct transmitter can also be made by the color of the plastic mould securing the Lukar clip which should be Maroon.

Parts numbers for the Spitfire and other models on the Smith Temperature Transmitter are as follows:

<u>Model</u>	<u>Smith's Code</u>	<u>STMCI Part No.</u>	<u>Volts</u>
Spitfire (up to FC-26303)	4801/00	137386	10
Spitfire (FC26303 onward)	4802/00	137705	10
Triumph 1200	4800/00	121997	12
TR4 (Concave Glass)	3802/00	131062	10
TR4 (Flat Glass)	3804/00	134435	10
Sports Six	4800/00	137386	10

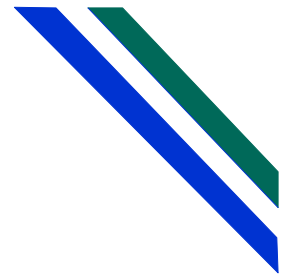

TO: ALL TRIUMPH DEALERS - WESTERN ZONE

ATTN: SERVICE DEPARTMENT

BULLETIN T-64-39

SUBJECT: CONVERTIBLE TOP STITCHING
CLEAR SEALER

DATE: DECEMBER 3, 1964

In the event of water seepage through the stitching on convertible tops, a cure can be effected by using "Leyland-Triumph Convertible Top Stitching Clear Sealer." This method will be used instead of replacing the convertible top.

This sealer should be used in the following manner:

1. Remove soft top from car.
2. Lay top on clean surface with interior uppermost.
3. Lift the front seam and with the use of the plastic nozzle on the tube of clearseal, apply a neat bead of sealing compound along entire length of stitches on under side of seam.

NOTE: Attention and care must be given in area of flap that snaps around top bows, as excess of sealing compound on under side of seam will present an unsightly appearance after reinstallation of top.

4. Allow front seam to return to normal position and proceed to run a further bead of sealing compound on the now uppermost stitches.
5. Repeat this on remaining stitched seams.
6. If an excess of sealer should get onto convertible top interior, it must be wiped off immediately with a clean dry rag, solvent material is Methyl Ethyl Ketone generally used in cheapest type lacquer thinner.
7. The drying period of clearseal is approximately 10 minutes.
8. If the above is carried out with care and attention, the entire operation will take less than 30 minutes.

Supplies of tubes of sealer complete with application nozzles are available by direct ordering from the Zone or Regional Parts Department. One tube should adequately cover 5 soft tops. The suggested price to dealer is \$1.50 per tube. Charges for labor and material on this basis will be acceptable for warranty purposes.

LEYLAND-TRIUMPH SALES COMPANY, INC.

WESTERN ZONE

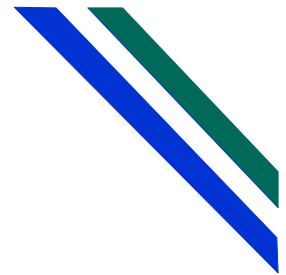

TO: ALL TRIUMPH DEALERS - WESTERN ZONE

ATTN: SERVICE DEPARTMENT

BULLETIN T-64-40

SUBJECT: CLUTCH RELEASE BEARINGS
SPITFIRE, 1200 AND TR-4

DATE: DECEMBER 3, 1964

A number of release bearings have been sent back to the factory for examination and the report has been returned that there is nothing wrong with the bearings themselves.

When changing clutches under warranty on the above models it is unnecessary to change the clutch thrust bearing unless there is a defect in the bearing. Should there be this defect then parts must be returned with the clutch and the invoice number of the new bearings must be submitted on the claim form. Should the bearings prove to be satisfactory upon inspection they will be returned to your parts department and the claim will be disallowed in respect to this item•

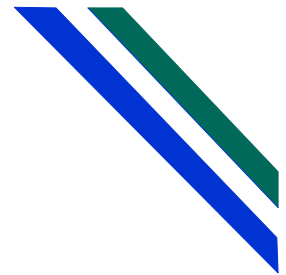

TO: ALL TRIUMPH DEALERS - WESTERN ZONE

ATTN: SERVICE DEPARTMENT

BULLETIN T-64-41

SUBJECT: TRIUMPH TR-4 WINDOW
WINDER REGULATOR

DATE: DECEMBER 10, 1964

When reports of stiffness in the operation of the door glass are received, the following procedure should be adopted which will prevent straining and damage to the regulator. The same instructions should also be followed when renewing a regulator.

1. Remove trim panel.
2. Raise window and check the clearance of the glass fore and aft in the top of the rear channel. The recommended clearance is .030" which should be maintained for the whole length of the channel. Excess clearance will allow tilting and the jamming of the glass and insufficient clearance will produce stiff operation. Clearance can be obtained by the use of packing washers between the inner door panel and top channel bracket (see illustration A-A).
3. Adjust bottom brackets and crimp the tie rod to ensure that the channels are parallel (illustration C).
4. Remove regulator pivot pin nut and delete spring washer under head of nut. Add washer WP0119 1/2"x 7/8" x .050" behind head of pivot bolt and additional washer WP0160 5/16" x 1 5/8" x 16 S.W.G. behind head of nut (illustration B-B).
5. Tighten nut sufficiently to allow ease of operation and peen or center pop end of thread.
6. Refit trim.

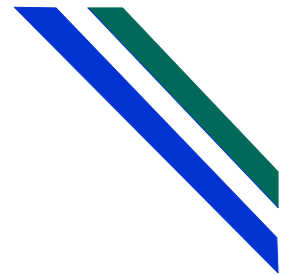

5/97

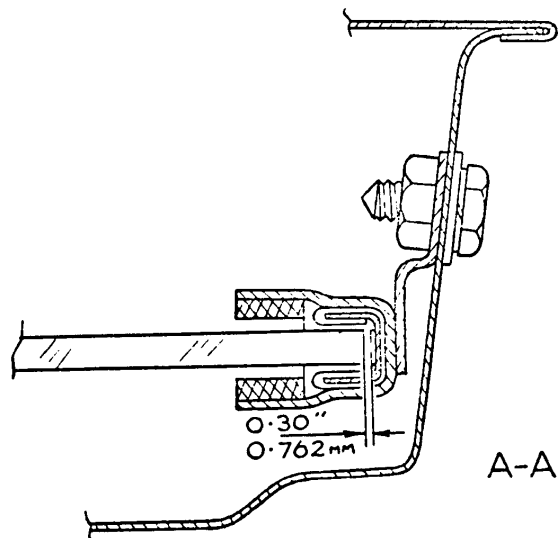
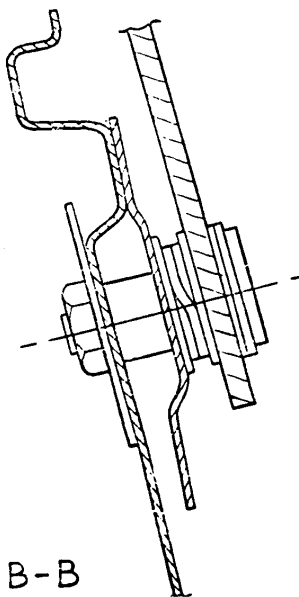
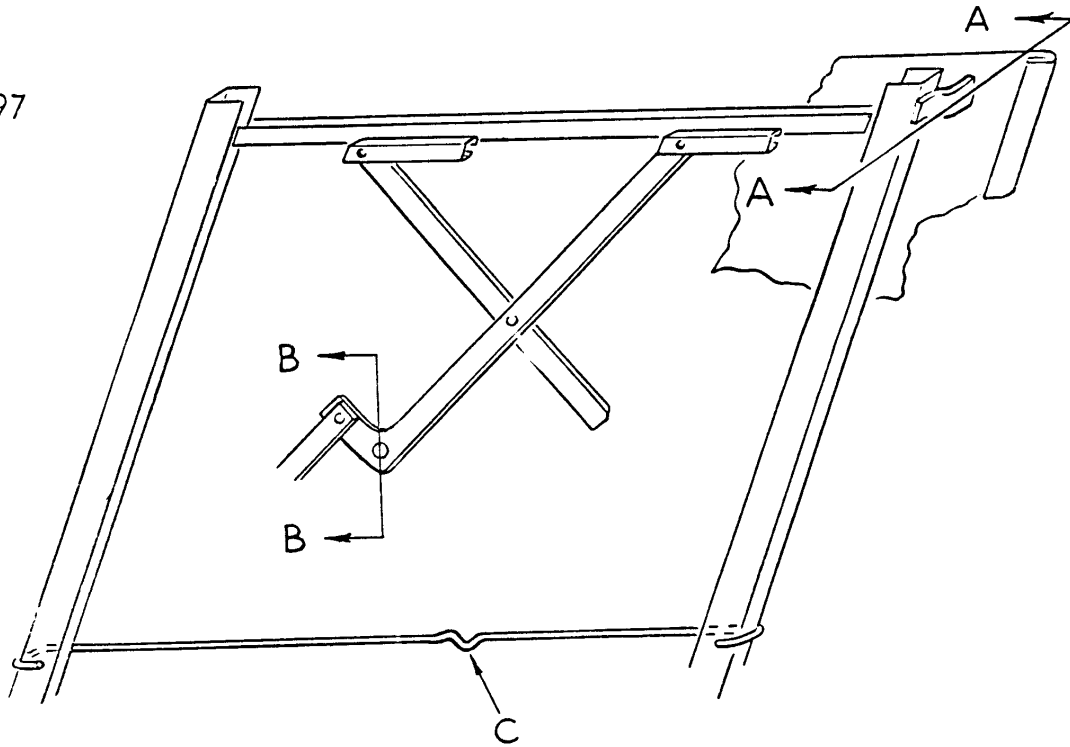

B-B

A-A

LEYLAND-TRIUMPH SALES COMPANY, INC.

WESTERN ZONE

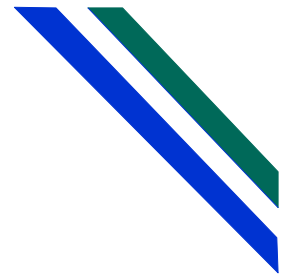

TO: ALL TRIUMPH DEALERS - WESTERN ZONE
ATTN: SERVICE DEPT.
SUBJECT: TRIUMPH TR-4, 1200, SPITFIRE
AND SPORTS SIX BRAKE HOSE ASSEMBLIES

BULLETIN T-64-42

DATE: DECEMBER 10, 1964

We have been advised by Girling that a new type hose end arrangement incorporating a 9/16" A.F. hexagon end will shortly supersede the 5/8" A.F. hexagon hose end.

Interchangeability is not affected but where pierced 5/8" hexagon lock plates are used, new 9/16" hexagon lock plates must be fitted with the new hose.

For Service purposes, the old part numbers allocated to the 5/8" hexagon hose will be retained for the 9/16" hexagon type and a warning label will be attached to the hose reading as follows:

WARNING

THIS HOSE IS FITTED WITH 9/16" HEXAGON END AND WHERE A PIERCED 5/8" HEXAGON LOCK PLATE IS USED, THIS MUST BE REPLACED BY A 9/16" HEXAGON LOCKING PLATE.

LEYLAND-TRIUMPH SALES COMPANY, INC.

WESTERN ZONE

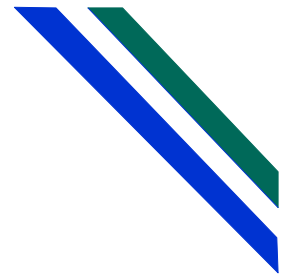

TO: ALL TRIUMPH DEALERS - WESTERN ZONE

ATTN: SERVICE DEPARTMENT

BULLETIN T-64-43

SUBJECT: STROMBERG CARBURETORS

DATE: DECEMBER 10, 1964

This bulletin is to advise you that all future warranty repairs to Stromberg carburetors on the TR4 in respect to fuel leakage from the float bowl, etc. that you should use the carburetor kit, part No. 514469.

This kit is comprised of carburetor gasket and seal set only, for one carburetor. The suggested retail price is \$1.38, dealer net 90¢.

This kit will eliminate your purchasing the larger carburetor set, part No. 513883, which is stocked by our parts department for a complete overhaul for both carburetors when this should become necessary.

All future warranty claim should be submitted with the small carburetor kit when repairs are performed on this carburetor. The larger kit, when claimed, will not be accepted.